



SUNDANCE™

BY

minkaAire®
A Minka Group® Co.

INSTRUCTION MANUAL WARRANTY CERTIFICATE

©2019 Minka Lighting Inc. Manual design and all elements of manual design are protected by United States Federal and/or State Law including Patent, Trademark and/or Copyright Laws.



Minka-Aire® warranty is for one (1) year from the date of purchase from an authorized Minka-Aire® dealer. This warranty is only valid to the original purchaser or user against all defects in material and workmanship (light bulbs excluded) for one (1) full year. Additionally, Minka-Aire® warrants the motor only for the lifetime of the Minka Aire ceiling fan (excluding wall controls and electrical components), to the original purchaser or user.

- * The warranty is voided with the use of any non- Minka-Aire® electrical devices, E.g., wall controls or electrical dimmer switches , etc...
- * The warranty is void once the original purchaser or user ceases to own the fan or the fan is moved from its original point of installation.
- * The warranty is void with the use of any hanger bracket (non-Minka Aire or non-fan specific) other than the hanger bracket supplied & installed with this specific fan.

Warranty Service Information

To obtain warranty service during the warranty period, the purchaser should return the fan with the sales receipt to the original place of purchase. The authorized Minka-Aire dealer, at its sole discretion, will either repair or replace the fan after verifying the legitimacy of the warranty claim. Replacement is subject to availability of the same model. If the model is unavailable it will be replaced by one of equal value. This is a limited warranty; the original purchaser or user is responsible for the cost of removal and reinstallation of repaired or replacement product.

To obtain the name of the Minka-Aire authorized dealer nearest you call the Minka-Aire customer care department at 1-800-307-3267, or contact Minka-Aire through www.minkagroup.net and select FAQ to answer any questions or if you require additional assistance submit the question form found there.

Date Purchased _____ Store Purchased _____ Model Number F571 Serial Number _____

SAFETY FIRST.....	1
PACKAGE CONTENTS.....	2
BEGIN INSTALLATION.....	3
HANGING THE FAN.....	4
ELECTRICAL CONNECTIONS.....	5
FINISHING THE INSTALLATION.....	6

ATTACHING THE FAN BLADES.....	7
OPERATING YOUR FAN.....	8
MAINTENANCE.....	9
TROUBLESHOOTING.....	10
SPECIFICATIONS.....	11

CONTENTS



1151W. Bradford Court, Corona CA 92882 For Customer Assistance Call: 1-800-307-3267



1

SAFETY FIRST

1. Before you begin installing the fan, shut power off at the circuit breaker of the fuse box.
2. Be cautious! Read all instructions and safety information before installing your new fan. Review accompanying assembly diagrams.
3. Make sure that all electrical connections comply with local codes, ordinances, or National Electrical Codes, ANSI/NFPA 70. Hire a qualified electrician or consult a do-it-yourself wiring handbook if you are unfamiliar with installing electrical wiring.
4. Make sure the installation site you choose allows the fan blades to rotate without any obstructions. Allow a minimum clearance of 7 feet from the floor and 18 inches from the tip of the blades to the wall.
5. If you are mounting the fan to a ceiling fan outlet box, use a U.L. Listed metal octagonal outlet box marked Acceptable for Fan Support. Secure the box directly to the building structure. The outlet box and its support must be able to support the moving weight of the fan (at least 50 pounds) Do not use a plastic box.
6. Caution: To reduce the risk of injury use only the screws provided with the outlet box in conjunction with the lock washers provided with the fan.
7. If you are mounting the fan to a joist, make sure it is able to support the moving weight of the fan (at least 50 pounds).
8. After you install the fan, make sure that all mounting components are secured to prevent the fan from falling.
9. Do not insert anything into the fan blades while the fan is operating.
10. Turn the fan off and wait for the blades to stop completely before performing any cleaning or maintenance.

**SUITABLE FOR USE IN
WET LOCATIONS**

NOTE:The important safeguards and instructions appearing in this manual are not meant to cover all possible conditions and situations that may occur. It must be understood that common sense, caution and care are factors which can not be built into this product. These factors must be supplied by the person (s) installing, caring for and operating the unit.

This Fan is suitable for Use In Wet Locations When Installed In A GFCI Protected Branch Circuit.

NOTE: READ AND SAVE ALL INSTRUCTIONS!

WARNING

TO REDUCE THE RISK OF FIRE, ELECTRIC SHOCK OR OTHER PERSONAL INJURY, MOUNT FAN ONLY TO A U.L. LISTED OUTLET BOX OR SUPPORTING SYSTEM MARKED ACCEPTABLE FOR FAN SUPPORT AND USE MOUNTING SCREWS PROVIDED WITH THE OUTLET BOX IN CONJUNCTION WITH THE LOCK WASHERS PROVIDED WITH THE FAN. MOST OUTLET BOXES COMMONLY USED FOR FAN SUPPORT OF LIGHTING FIXTURES ARE NOT ACCEPTABLE FOR FAN SUPPORT AND NEED TO BE REPLACED. CONSULT A QUALIFIED ELECTRICIAN IF IN DOUBT.

TO REDUCE THE RISK OF PERSONAL INJURY, DO NOT BEND THE BLADE HOLDERS WHILE INSTALLING, BALANCING THE BLADES OR CLEANING THE FAN. DO NOT INSERT FOREIGN OBJECTS BETWEEN ROTATING FAN BLADES.

TO REDUCE THE RISK OF FIRE OR ELECTRONIC SHOCK, DO NOT USE THIS FAN WITH ANY SOLID-STATE SPEED CONTROL DEVICE.

2

PACKAGE CONTENTS

- | | |
|---|---|
| 1. Fan blade | screws (2 pcs) |
| 2. Coupling cover | #10-12X38mm wood screws (2 pcs) |
| 3. Fan motor/housing ass'y | Spring washers (2 pcs) |
| 4. Switch Cup | Star washers (2 pcs) |
| 5. Blade bracket | Metal washers (2 pcs) |
| 6. Mounting bracket with Rubber pad attached | 11. Blade Attachment Hardware:
3/16"X8mm screws (16 pcs) |
| 7. Canopy | 5X10mm rubber washers (16 pcs) |
| 8. Canopy cover | 12. Bracket Attachment Hardware:
1/4"X12.7mm screws (11 pcs) |
| 9. Standard downrod assembly(6") | 13. Switch Cup Hardware: |
| 10. Mounting Hardware :
#8-32X38mm machine | |

Unpack your fan and check the contents. You should have the following items:

- Pull Chain Fb (1pc.)
Wire Nuts (3 pcs.)
Balancing Kit
14. Rubber Cap (1pc.)

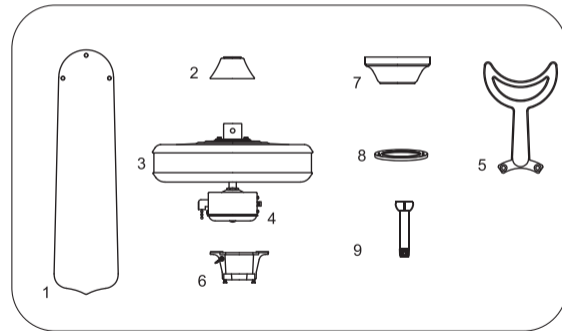
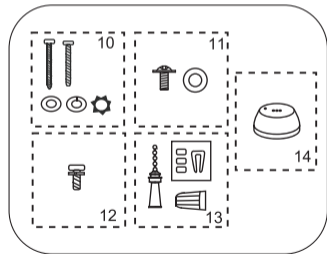

Tools Required: Phillips screw driver; slotted screw driver; pliers; wire cutters; electrical tape.

BEGIN INSTALLATION

MOUNTING OPTIONS

If there isn't an existing outlet box, then read the following instructions. Shut the power off at the circuit breaker or fuse box.

Secure the outlet box directly to the building structure. Use appropriate fasteners and building materials. The outlet box and its support must be able to fully support the moving weight of the fan (at least 50 lbs.). Use a U.L. Listed metal outlet box marked "Acceptable for ceiling fan support". Do not use a plastic outlet box.

Figures 1, 2 and 3 are examples of different ways to mount the outlet box.

Note: You may need a longer downrod to maintain proper blade clearance when installing on a steep, sloped ceiling. Longer downrods are available from your Minka-Aire dealer.

To hang your fan where there is an existing fixture but no ceiling joist, you may need to install a hanger bar as shown in Fig. 4 (available at your Minka-Aire dealer).

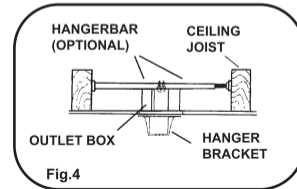
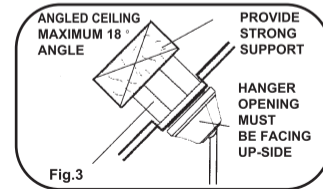
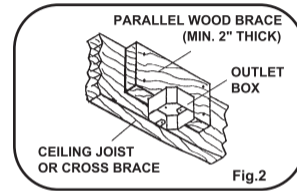
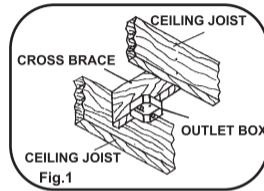

4

HANGING THE FAN

WARNING: All of the parts, hardware and components such as the hanger bracket and hanger ball have been provided for your safety and the proper installation of your new ceiling fan. The use of other parts, hardware or components not supplied by Minka Aire® with the fan will void the Minka Aire® Warranty.

REMEMBER to shut the power off at the circuit breaker or fuse box.

Step 1. Secure the hanger bracket to the ceiling outlet box using screws provided with the outlet box and flat washers included with the fan. (Fig. 5) Note: Optional wood screws are provided for mounting of hanger bracket directly to building structure.

Step 2. Loosen the two set screws in the top coupling of the top housing assembly. (Fig. 6)

Step 3. Remove downrod hanger ball by loosening set screw, removing the cross pin, and sliding ball off rod. Remove the hitch pin and lock pin. (Fig. 7)

Step 4. Carefully feed fan wires up through the downrod and then through the holes in the rubber cap on the top of the downrod. Insert the rod into the coupling and tighten onto fan until the holes are aligned. Next, replace lock pin and hitch pin. Tighten the set screws. (Fig. 8)

Step 5. Slip coupling cover, canopy cover, and canopy onto downrod (Fig. 9). Carefully reinstall hanger ball onto rod being sure that cross pin is in the correct position, set screws are tightened and wires are not twisted.

Step 6. Now lift motor assembly into position and place hanger ball into hanger bracket. Rotate until the check groove has dropped into the registration slot and seats firmly. (Fig. 10) Rod should not rotate if this is done correctly.

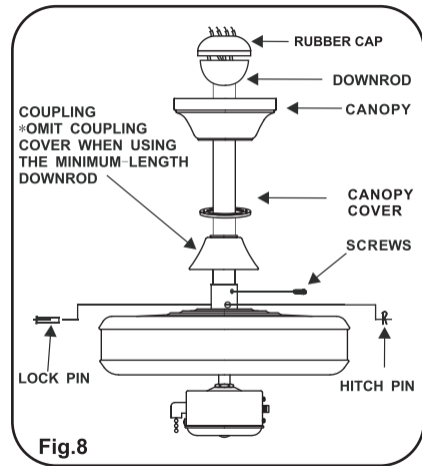
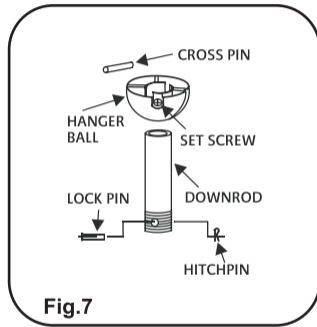
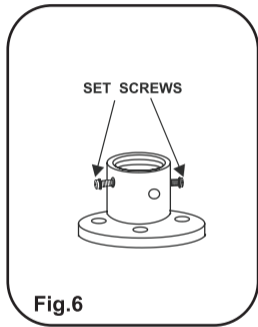
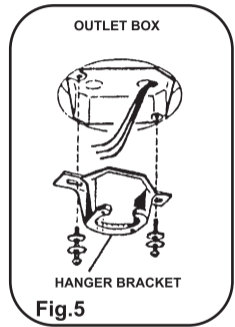

5

ELECTRICAL CONNECTIONS

REMEMBER to shut the power off at the circuit breaker or fuse box.

Follow the steps below to connect the fan to your house supply wires. Use the wire nuts supplied with your fan. Secure the wire nuts by wrapping the connection with electrical tape.

Step 1. Connect the black(hot)wire from the ceiling to the black and the blue wires from the fan. Connect the white(Neutral)wire from the ceiling to the white wire from the fan.(Fig 10)

Step 2. If your outlet has a ground wire(Green or Bare Copper)connect the fan ground wires (on hanger ball and hanger bracket)to it;otherwise, connect the fan ground wire on hanger ball directly to hanger bracket.

Step 3. After the splices are made, spread the wires apart so that the green and white wires are one side of the outlet box and the black wire

(and the blue wire if light kit is installed)are on the other side of the outlet box. Turn splices upward and tuck them carefully into outlet box.

Figure 11 & 12 Illustrate the wiring connections using optional wall unit. (Available at your Minka-Aire Retailer.)

NOTE: If a light kit is not included with your fan, one can be purchased at your Minka-Aire Retailer. Use only with light kits marked "Suitable for use in wet location."

FAN CONTROLLED BY PULL CHAIN, LIGHT KIT CONTROLLED BY PULL CHAIN.

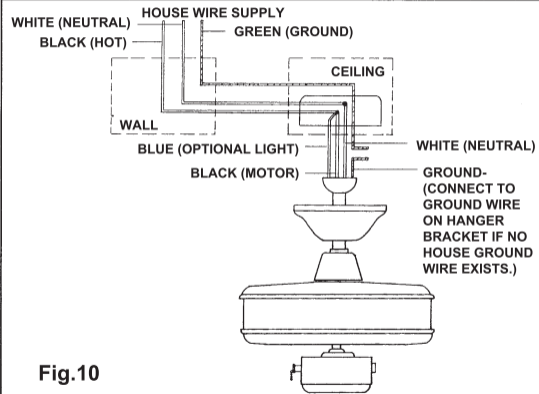
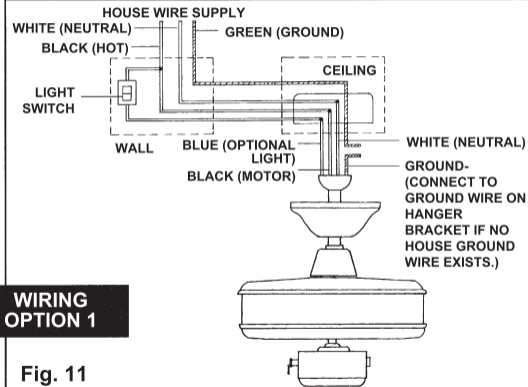

Fig.10

FAN CONTROLLED BY PULL CHAIN, LIGHT KIT CONTROLLED BY WALL SWITCH.



WIRING
OPTION 1

Fig. 11

FAN CONTROLLED BY WALL CONTROL, LIGHT KIT CONTROLLED BY LIGHT SWITCH.

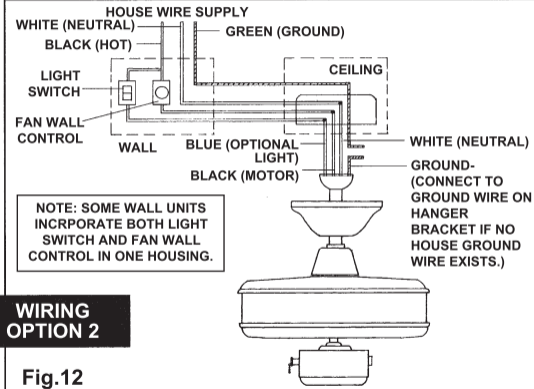

WIRING
OPTION 2

Fig.12

FINISHING THE INSTALLATION

Step 1. Remove 1 of the 2 screws from the bottom of the hanger bracket and loosen the other one half a turn from the screw head.

Step 2. Slide the canopy up towards the hanger bracket and place the key hole on the canopy over the screw on the hanger bracket, turn canopy until it locks in place at the narrow section of the key holes. (Fig. 13)

Step 3. Align the circular hole on canopy with the remaining hole on the hanger bracket, secure by tightening the two set screws.

Step 4. Place the canopy cover to the canopy and rotate canopy cover clockwise until it is locked into right position. (Figure 13)

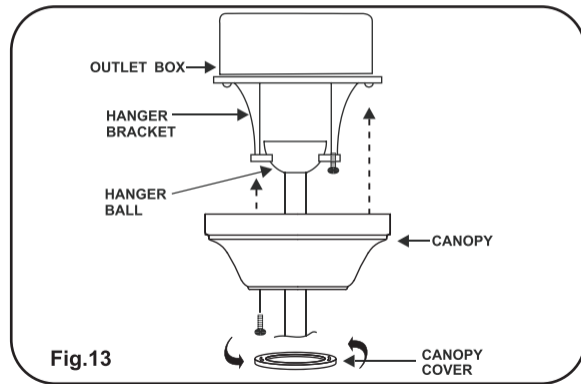

ATTACHING THE FAN BLADES

Step 1. Attach the fan blade to the blade bracket using rubber washer and screws provided. Tighten screws securely. Repeat for remaining blades. (Fig. 14)

Step 2. Remove and discard the rubber stops from the motor. Align holes in blade bracket and motor and secure with proper screws. Repeat process with the other blade brackets. (Fig. 15)

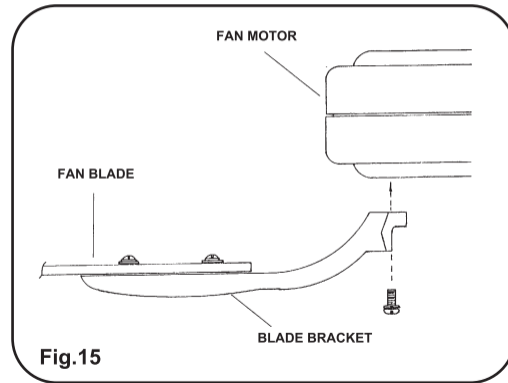
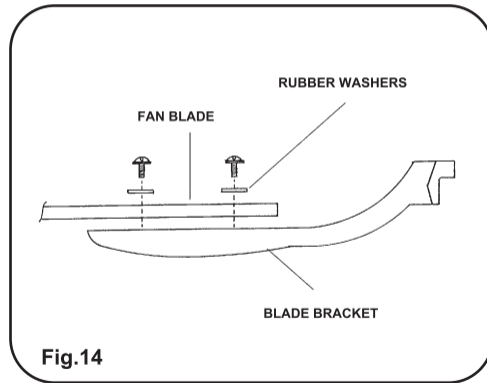

OPERATING YOUR FAN

Restore power to ceiling fan and test for proper operation.

Speed settings for warm or cool weather depend on factors such as the room size, ceiling height, number of fans, etc.

The slide switch, on the switch cup, controls the forward or reverse direction of the fan. Down or to the left is for warm weather operation. Up or to the right is for cool weather operation.

NOTE

Wait for fan to stop before changing the setting of the SLIDE SWITCH.

Warm weather- (Forward)

A downward air flow creates a cooling effect as shown in Figure 16. This allows you to set your air conditioner on a warmer setting without affecting your comfort.

Cool weather- (Reverse) An upward airflow moves warm air off the ceiling area as shown in Figure 17. This allows you to set your heating unit on a cooler setting without affecting your comfort.

The pull chain on your fan controls the speed settings as follows:

- 1st pull-High Speed
- 2nd pull-Medium Speed
- 3rd pull-Low Speed
- 4th pull-Turns Fan Off

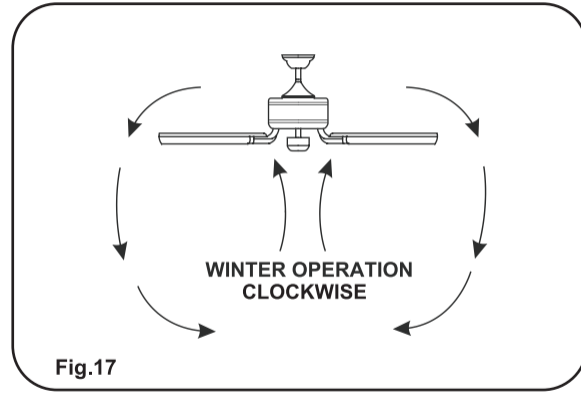
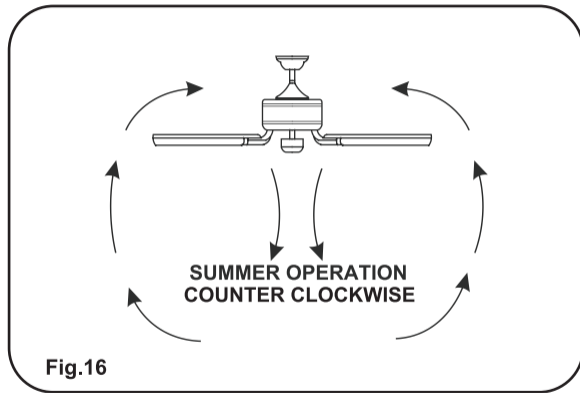

MAINTENANCE

Here are some suggestions to help you maintain your fan.

1. Because of the fan's natural movement, some connections may become loose. Check the support connections, brackets, and blade attachments twice a year. Make sure they are secure. (It is not necessary to remove fan from ceiling.)
2. Clean your fan periodically to help maintain its new appearance over the years.
3. Use only a soft brush or lint-free cloth to avoid scratching the finish. The plating is sealed with a lacquer to minimize discoloration or tarnishing.
4. There is no need to oil your fan. The motor has permanently lubricated bearings.

WARNING
MAKE SURE THE POWER IS OFF AT THE ELECTRICAL PANEL BOX BEFORE YOU ATTEMPT ANY REPAIRS. REFER TO THE SECTION, "MAKING ELECTRICAL CONNECTIONS".

TROUBLESHOOTING

Problem Solution

Problem

Fan will not start.

Solution

1. Check fuses or circuit breakers.
2. Check line wire connections to fan and switch wire connections in switch housing.

CAUTION: Make sure main power is off.

3. Check to make sure the reverse is set to one side. If the switch is located in the middle it might not make proper contact.

Problem

Fan sounds noisy.

Solution

1. Allow a 24-hour "break-in" period. Most noises associated with a new fan go away during this time.
2. Make sure all motor housing screws are snug.
3. Make sure the screws that attach the fan blade bracket to the motor hub are tight.
4. Some fan motors are sensitive to signals from solid-state variable speed controls. If you have installed this type of control, choose and install another type of control.

Problem

Fan Wobble

Solution

1. Make sure your hanger bracket and outlet box are secure.
2. If a Balancing kit is provided follow the instructions included with the balancing kit to help correct any excessive wobble.

NOTE: All blades sets are grouped by weight. Because plastic injection materials vary in density, the fan may wobble even though blades are weight matched.

SPECIFICATIONS

These are typical readings. Your actual fan may vary. They do not include amps or wattage used by the light kit.

Fan Size	Speed	Volts	Amps	Watts	RPM	N.W.	G.W.	C.F.
52"	Low	120	0.22	8.87	66	7.30	8.50	1.9'
	High	120	0.57	68.11	192	kgs	kgs	

For any additional information about your Minka-Aire Ceiling Fan, please write to:



1151 W. Bradford Court, Corona, CA 92882 • For customer assistance call: 1-800-307-3267

MKA11042503

PERFORMANCE AND ENERGY INFORMATION

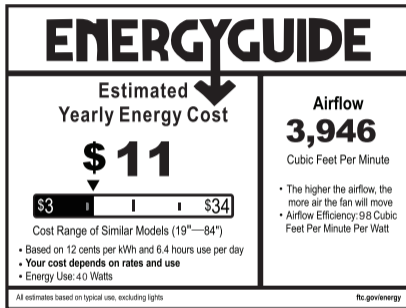

FAN SPEED	AIRFLOW (CFM)*	POWER USE (watts)	AIRFLOW EFFICIENCY (CFM/watt)
Low	1808	8.87	203
High	5832	68.11	85

Ceiling fan airflow is measured in cubic feet per minute (CFM). Power use is measured in watts. To maximize energy savings:

- Choose a fan with high airflow efficiency (CFM/watt).
- Use ENERGY STAR®-labeled lighting in your fan.
- Remember to switch off your fan when you leave the room.

* Measured according to the ENERGY STAR® approved Solid State test method

For any additional information about your Minka Aire® Ceiling fan, please write to:

1151 W. Bradford Court, Corona, CA 92882 • For Customer Assistance Call: 1-800-307-3267

