

# INSTALLATION INSTRUCTIONS FOR 4115 & 4215

**WARNING! SHUT POWER OFF AT FUSE OR CIRCUIT BREAKER**  
**AVERTISSEMENT! COUPER LE COURANT AU NIVEAU DES FUSIBLES OU DU DISJONCTEUR**

## WARRANTY-

This product is warranted to be free of defects in material and workmanship for one (1) year from date of purchase. This warranty is limited to the correction of any such defect, or the replacement of any such defective item, provided that: (a) we are properly notified and consent to the return of the item(s) in question; (b) the items is/ are returned with the proof of purchase date; and (c) it is found upon inspection by us that item(s) is /are defective as noted above. This warranty does not cover labor costs, consequential damages, nor does it apply to any item(s) that have been improperly installed, overloaded, altered, or otherwise abused by the customer, its agent(s) or employee(s). We make no warranty, express or implied, and disclaim any warranty if merchantability or fitness for a particular purpose.

## RAIL SYSTEM

Installing your Rail System READ THESE INSTLLATION INSTRUCTIONS BEFORE YOU BEGIN INSTALLING THIS NEW RAIL SYSTEM.

1. Use maximum 50 Watt bulbs on this system.
2. Make sure all connections are tight and secure.
3. Do not install any components of this system to any metal surface.
4. For use with models 4115 & 4215 rail systems only.

**Tools Needed:** Slotted screwdriver, Adjustable wrench, Electrical Hand drill, Step ladder, Wire cutters, Wiring supplies as required by electrical code.

**Rail System:** Use only with electrical fittings identified for use with the 4115-4215 rail systems.

**TRACK SYSTEM** (to be only used with the electrical fitting identified for use with the 4115 & 4215 track system)

## Table of Contents

- A. Package Contents
- B. Installing the power canopy
- C. Preparing the Rail sections for Installation.
- D. Installing Track Connectors
- E. Installing the Rails to the Ceiling
- F. Installing the Fixtures
- G. Restoring the Electrical Power
- H. Important Safety Instructions

This track system is to be supplied by a single branch circuit of 120 volts, single phase. Not intended for use with a power supply cord or convenience receptacle adapter.

**This track is only to be used with other electrical fittings identified for use with the track system.**

**CAUTION/ MISE EN GARDE:** Before you begin installing your new rail system; **disconnect the power/ déconnectez la puissance** by removing the fuses or turning off the circuit breakers.

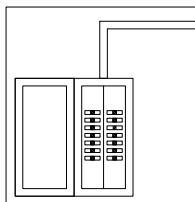

## A. Package Contents

Unpack your new rail system; you should have the following;  
A- Rail track, B- Power canopy, C- Ceiling support stems, D- Fixtures, E- Track connectors, F&G- PE bag of mounting hardware including spare parts.

Model: 4115      Model: 4215  
Model: 4115 & 4215 includes: 5pcs glass and 6pcs bulbs.

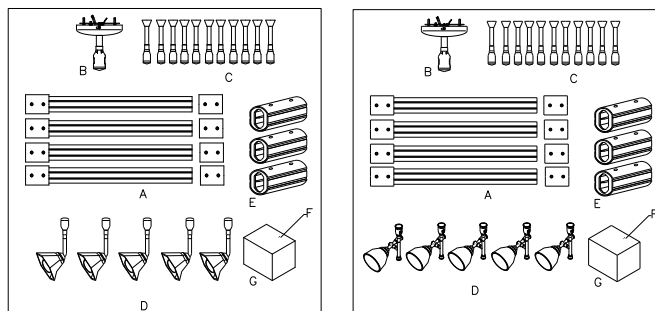

## B. Installing the Power canopy (AS SHOWN IN DIAGRAM)

**Step 1.** Locate canopy (B) and canopy mounting hardware packet (F) which contains 2pcs screws and 3pcs wire connectors.

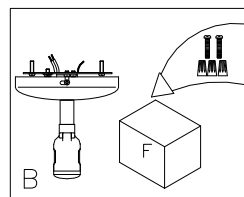

**Step 2.** Install mounting bracket to existing outlet box with screws.

**Step 3.** Pull wires through mounting bracket.

**Step 4.** Connect the bare (ground) wire from the canopy to the bare or green ground wire from the outlet box use a wire connector to secure the connection.

**Step 5.** Connect the white (neutral) wire from the canopy to the white wire from the outlet box. Use a wire connector to secure the connection. Do the same with black wire. Make sure all wires are tucked in.

**Step 6.** Secure Outlet Box Canopy to the mounting bracket with the screws provided.

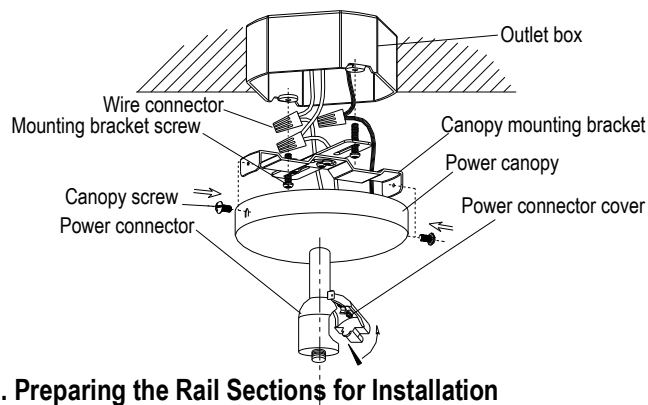

## C. Preparing the Rail Sections for Installation CREATE LAYOUT

The line voltage flexible track kit allows you maximum flexibility in creating an attractive lighting system for your room. The tracks can be mounted in an infinite combination of curves and straight runs. The adjustable track heads can be mounted anywhere along the track run.  
**Step 1.** Locate the four sections of rail and joiners packet (A), which contains three track connectors and the several set screws.

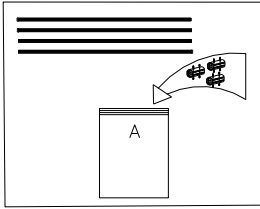

**Step 2.** To bend or curve the rail, follow step 3, If the rail will be mounted as a straight run, skip to step 4.

**Step 3.** Use a round kitchen tabletop or similar household item as a template to bend the rail. Carefully hold the rail with one hand starting from the center and working towards the ends. Table Top (A), Waste Paper Basket (B), Counter Top (C) Plywood Template (D)

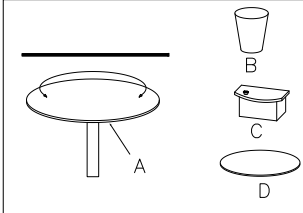

### D. Installing Track Connectors (Joins Two Sections Of Track End To End)

1. Loosen set screws of the connectors to allow the track to slide into the connector.
2. Loosen set screws of the end caps and remove end caps from track section to be joined.
3. Insert track, one at a time, into each side of the connector until they stop.

**Note:** Do not force track into connector, check alignment of conductors and tabs. Properly align the electrical contact tabs inside the connector to the corresponding conductors in the track section. See track diagram above, showing 2 round copper conductors on one side and a flat conductor (ground) on the other side.

4. Tighten set screws of connectors to hold the track in place.
5. Repeat the same methods to connecting the other track sections through with track connector, your can mounted two or most four tracks as your needed, just keep only two end caps in final the end of track.

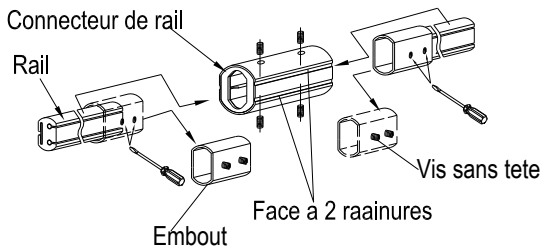

### E. Installing the Rails to the Ceiling

**Step 1.** Locate the 11 stanchions and mounting hardware packet (B) which contains 11 screws and 11 pcs anchors.

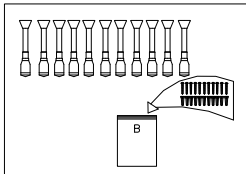

**Step 2.** Installing the track to the canopy. Remove the retaining cap on the power connector. Open the power connector cover and align the two slots of the track to the two tabs on the power connector. Close the power connector cover and replace the retaining cap making sure that the connection is secure.

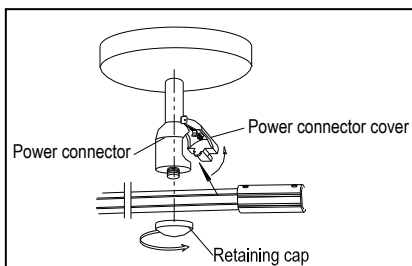

**Step 3.** The canopy and the stanchions will be used to support the rail from the ceiling providing a total of twelve supports. Use a pencil and tape measure to mark two of the support locations on the rail 10" from each end of the rail.

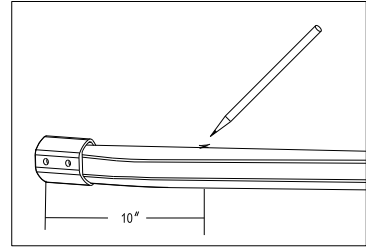

**Step 4.** Lift the rail to the ceiling. Lining the rail up with the canopy, Use a pencil to transfer the stanchion locations to the ceiling.

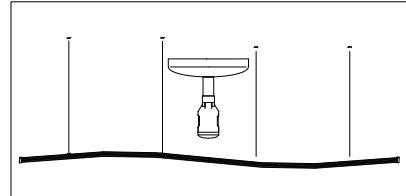

**Step 5.** Line up the drywall anchors with the marks on the ceiling and use a hammer to tap the anchor approximately 1/2" into the ceiling. Stop just before the threaded portion of the anchor enters the ceiling.

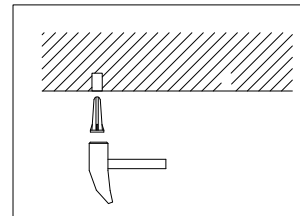

**Step 6.** Finish the installation using a screw driver to secure the stanchion holder into the anchor with tapping screws until it is in place.

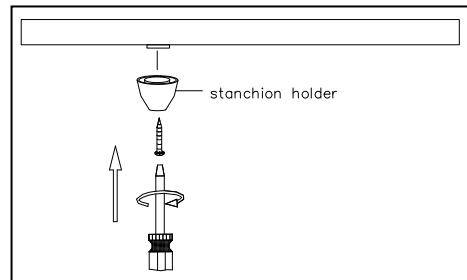

**Step 7.** Secure the stanchion assembly to the threaded stanchion holder. Repeat step 5 and 7 for the remaining stanchions.

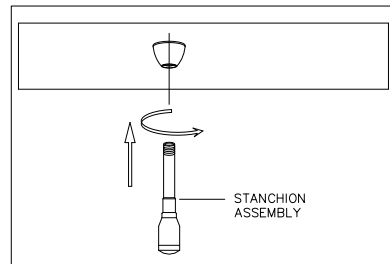

**Step 8.** Remove the retaining cap, open the track mounting bracket, and then insert the flexible track into the track mounting bracket. Replace the retaining caps to secure the flexible track.

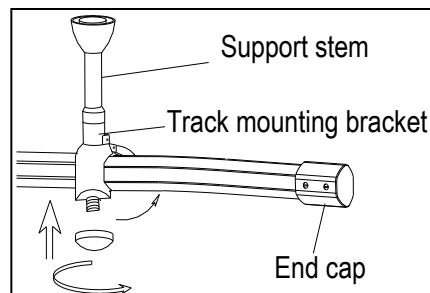

## F. Installing the Fixtures

### FOR 4115

First installing the bulb and then remove the retaining caps from the fixtures. Align the two tabs of the track fixture adaptor to the two slots on the flexible track. Close the fixture adapters and replace the retaining caps making sure that the connection is secure.

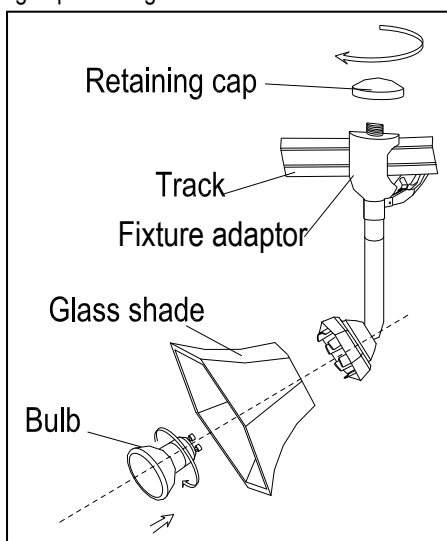

### FOR 4215

First installing the glass shade and bulb and then installing the fixtures, same as above. (AS SHOWN IN DIAGRAM)

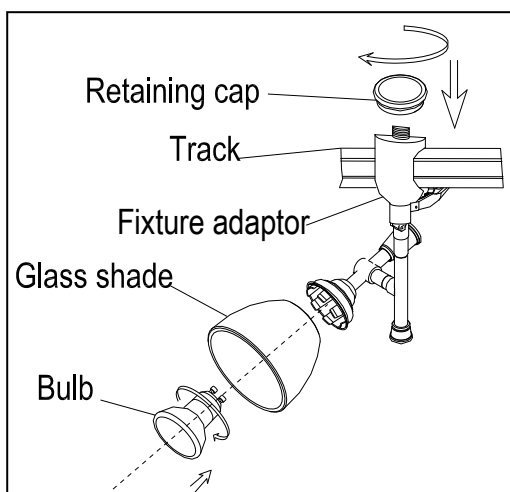

## G. Restoring the Electrical Power

**Step 1.** Restore the electrical power and proceed to test your new rail system.

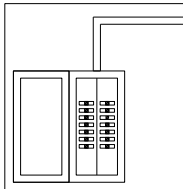

**Step 2.** Turn on the light system and let it run for 5 minutes. Turn the system off, carefully check that all connection points are not hot to the touch (warm is acceptable), if a connection is hot, check the connection and make sure the wire nut is tightly secured.

Power Feed Connection (A) Fixture Connections (B)

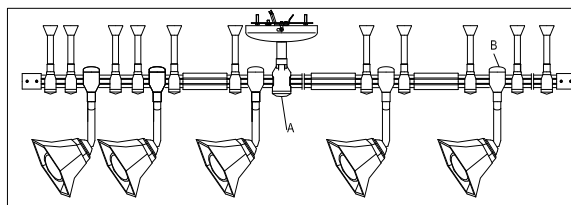
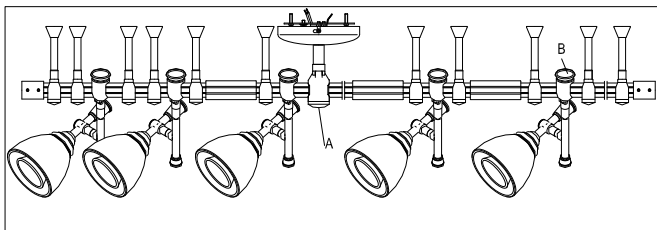

**IMPORTANT:** When replacing GU10 shielded bulbs, be sure the wattage of the bulb is 50W or Less. / **IMPORTANT :** Quand le remplacement de GU10 a protégé des ampoules, soit sûr que la puissance en watts de l'ampoule est 50W ou moins.

## GENERAL /GÉNÉRAL

1. Be sure to read these installation instructions and review the diagrams thoroughly before installing the lighting system./ Veuillez lire ces instructions d'installation et passer en revue les diagrammes de façon approfondie avant d'installer le système de rail.
2. All electrical connections must be in accordance with local codes and the National Electrical Code. If you are unfamiliar with methods of installing electrical wiring, secure the services of a qualified licensed electrician./ Tous les branchements électriques doivent être conformes aux codes locaux et au Code national de l'électricité. En cas de doute quant aux méthodes d'installation de câblage électrique, réserver les services d'un électricien accrédité qualifié.
3. These fixtures are intended to be mounted to a 4" square x 2-1/8" deep metal octagon outlet box. The box must be directly supported by the building structure./ Cet appareil d'éclairage est conçu pour être fixé à une boîte de jonction métallique octogonale d'une largeur de 10,16 cm et d'une profondeur de 5,40 cm. Celle-ci doit être fixée directement à la structure du bâtiment.
4. Before starting the installation, disconnect the power by turning off the circuit breaker or by removing the appropriate fuse at the fuse box. Turning the power off using the light switch is not sufficient to prevent electrical shock./ Avant d'entamer l'installation, débrancher l'alimentation électrique en fermant le disjoncteur ou en retirant le fusible approprié dans la boîte à fusibles. Couper l'alimentation électrique en éteignant l'interrupteur mural est insuffisant pour prévenir les chocs électriques.

**Note:** The important safeguards and instructions appearing in this manual are not meant to cover all possible conditions and situations that may occur. It must be understood that common sense, caution and care are factors that cannot be built into any product. These factors must be supplied by the person(s) caring for, installing and operating the fixture./

**Remarque :** Les mesures de sécurité et instructions de ce manuel ne sont pas destinées à couvrir toutes les conditions et situations possibles. Le bon sens, la prudence et les précautions sont des qualités qui ne peuvent être intégrées à aucun produit. Il incombe à la personne qui installe et utilise l'appareil d'éclairage d'agir en fonction de ces qualités

**CAUTION: Do not touch hot lens, guard or enclosure./ MISE EN GARDE: Ne pas toucher au diffuseur, au protecteur ou au boîtier.**

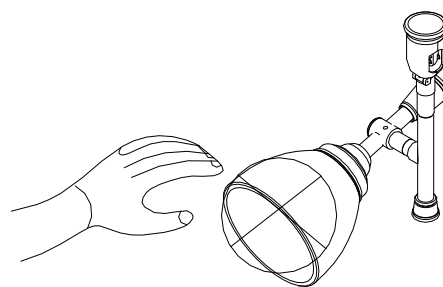

## H. Important Safety Instructions

### Consignes de sécurité importantes

1. Read all instructions./ Bien lire toutes les instructions.
2. Do not install this lighting system in a damp or wet location./ Ne pas installer ce système d'éclairage dans un endroit humide ou mouillé.
3. Before energizing make sure that the lighting system is clear of all material which could cause a direct short and check all electrical connections to make sure they are tight./ Avant d'alimenter l'appareil, s'assurer que le système d'éclairage ne touche aucun matériau qui pourrait causer un court-circuit et vérifier tous les branchements électriques afin d'être certain qu'ils sont bien serrés.
4. **CAUTION - Hot surface, keep away from curtains and other combustible materials./ MISE EN GARDE - Surface chaude! Tenir éloigné des rideaux ou de toute autre matière combustible.**

5. Lighted lamp is hot! Do not touch lamp at any time. Use a soft cloth or relamping tools (see diagram), Oil from skin may damage lamp. Turn off power and allow bulbs to cool before replacing./ La lampe est chaude lorsqu'elle est allumée! Ne jamais toucher l'ampoule. Utiliser un linge doux car l'huile de la peau peut endommager l'ampoule ou un outil de remplacement des lampes (voir diagramme), Coupez l'alimentation électrique et laissez l'ampoule refroidir avant de la remplacer.
6. Lamp gets hot quickly! Contact only switch or plug when turning on. Do not touch hot lamp lens./ La lampe se réchauffe rapidement! Utiliser seulement un interrupteur ou une prise pour l'allumer. Ne jamais toucher une lentille de lampe chaude.
7. Do not conceal or extend bus-bar conductors through a building wall./ Ne pas dissimuler ou rendre accessibles des conducteurs sur barres dans un mur en construction.
8. Do not install any part of this system (TRACK) less than 7 feet (2.2m) above floor./ N'installez aucune pièce du système (rail) à moins de 2,1 m (7 pi) du sol.
9. To reduce the risk of fire and burns, do not install this lighting system where non insulated open bus-bar conductors can be shorted or contact any conductive metals./ Pour réduire les risques d'incendie et de brûlures, ne pas installer ce système d'éclairage en présence de conducteurs sur barres ouverts et non isolés qui peuvent se mettre en court-circuit ou venir en contact avec des métaux conducteurs.
10. To reduce the risk of fire and overheating, make sure all connections are tight./ Pour réduire les risques d'incendie ou de surchauffe, s'assurer que toutes les connexions sont serrées.
11. Do not install any lamps closer than 6 inches (15cm) from any curtain or similar combustible material./ N'installez aucune lampe à moins de 15 cm (6 po) de tout rideau ou autre matériau combustible similaire.
12. Turn off electrical power before modifying the light system in anyway./ Couper l'alimentation électrique avant d'apporter des modifications au système d'éclairage de quelque nature que ce soit.
13. Use minimum 20" spacing between stanchions./ Employez le minimum 20" ; espacement entre les supports.
14. For use with EC series line voltage flexible track system only. Do not cut any track sections./ À utiliser uniquement avec les systèmes de rail d'éclairage flexible à tension secteur série EC. Do not cut any track sections.
15. CAUTION – To reduce the risk of a burn during relamping, remove from the track before relamping./ **MISE EN GARDE:** Afin de réduire les risques de brûlure au cours du changement d'une ampoule, retirez le projecteur du rail avant de changer l'ampoule.
16. This track system is to be supplied by a single branch 120 volt circuit./ Ce système d'éclairage sur rail doit être alimenté par un circuit de dérivation simple de 120 volts.
17. Disconnect electrical power before adding to or changing the configuration of the track./ Débrancher le courant électrique avant d'apporter des ajouts ou des modifications à la configuration de ce rail.
18. Do not attempt to energize anything other than lighting track fixture on the track. To reduce the risk of fire and electric shock, please do not attempt to connect power tools, extension cords, appliances and the like to the track./ Utiliser uniquement des luminaires conçus pour les systèmes d'éclairage sur rail. Pour réduire les risques d'incendie et de chocs électriques, ne pas tenter de brancher des outils électriques, des rallonges électriques, des appareils et des articles semblables sur le rail.
19. The track system is not intended for use with a power supply cord or convenience receptacle adaptor./ Ce système de rail n'a pas été conçu pour utilisation avec un cordon d'alimentation ou avec un adaptateur de prise de courant.
20. Pendant mounted track intended to be installed by stems only are not to be mounted by cable./ Les rails conçus pour un montage de suspension par tiges seulement ne doivent pas être montés par câbles.
21. Save these instructions and refer to them when additions to or changes in the track configuration are made./ Conservez ces instructions et consultez-les si dans l'avenir vous désirez effectuer des ajouts ou apporter des modifications au rail d'éclairage.

**SAVE THESE INSTRUCTIONS  
CONSERVER CES INSTRUCTIONS**