

INSTALLATION INSTRUCTIONS

Item#6394 (New. 04/03/2013)

READ AND SAVE THESE INSTRUCTIONS

WARNING! SHUT POWER OFF AT FUSE OR CIRCUIT BREAKER.
AVERTISSEMENT! COUPER LE COURANT AU NIVEAU DES FUSIBLES OU DU DISJONCTEUR.

PREPARATION (Fig.1)

1. Shut off the power at the fuse box or circuit breaker. If necessary, remove the old fixture, including the mounting hardware.
2. Carefully remove the fixture from the carton and check that all parts are included as shown in the illustration. Prior to installing glass, remove screws (G) and metal frame (H) from fixture body (C).
3. Attach the Mounting Plate (A) to the Junction Box using Junction Box Screws (B). The side of the mounting plate marked "GND" must face out.

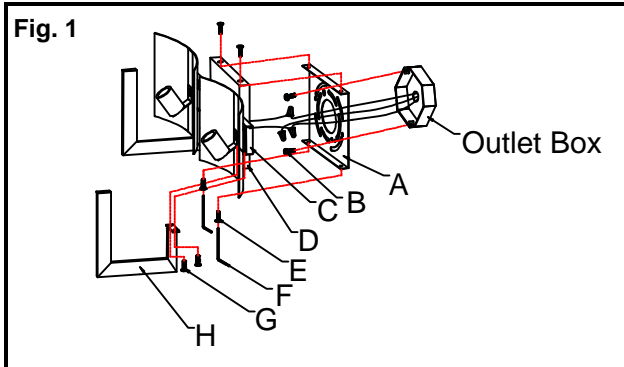

MOUNTING THE FIXTURE (Fig.2 & 4)

4. Place the Allen screw (N) over the Plastic Washer (O), Diffuser Glass Shade (P) and Metal Plate (Q) secure with Metal Frame (H), then place the Screw (L) through the Plastic Washer (K), Glass Panel (M) and Metal Plate (I) secure with Metal Frame (H).
5. Install the Xenon bulb (included) in accordance with the fixture's specifications. **(DO NOT EXCEED THE MAXIMUM WATTAGE RATING!) (NE PAS DEPASSER LA PUISSANCE NOMINALE MAXIMALE!)**
6. Secure the Metal Frame (H) onto the Fixture Body (C) by using Screws (G).

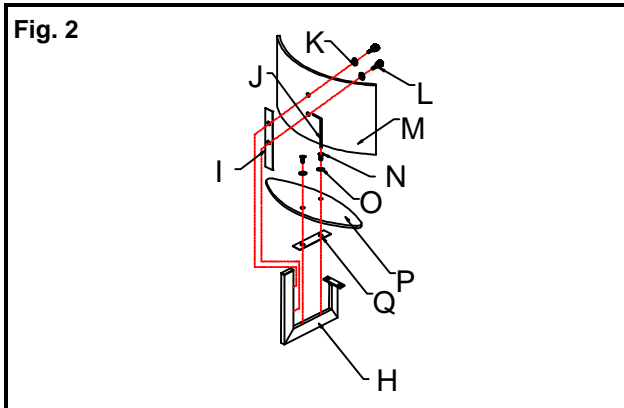

CONNECTING THE WIRES (Fig. 3)

7. At this point, connect the electrical wires as shown in Fig. 3, making sure that all wire connectors are secured. If your outlet box has a ground wire (green or bare copper), connect the fixture's Ground Wire to it. Otherwise, connect the fixture's Ground Wire directly to the mounting plate using the Green Screw provided. After wires are connected, tuck them carefully inside the Junction Box.

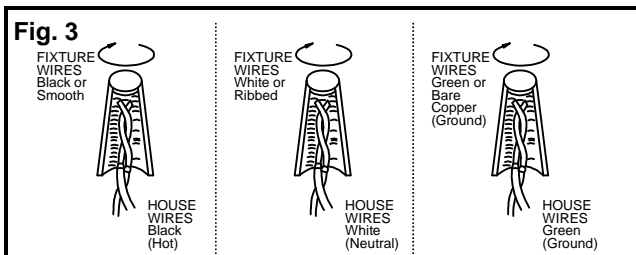

FINISHING THE INSTALLATION (Fig.4)

8. Place Fixture Body (C) over Mounting Plate (A), fasten with Screws (D) by using Allen Wrench (R) provided.

Your installation is now complete. Return power and test the fixture.

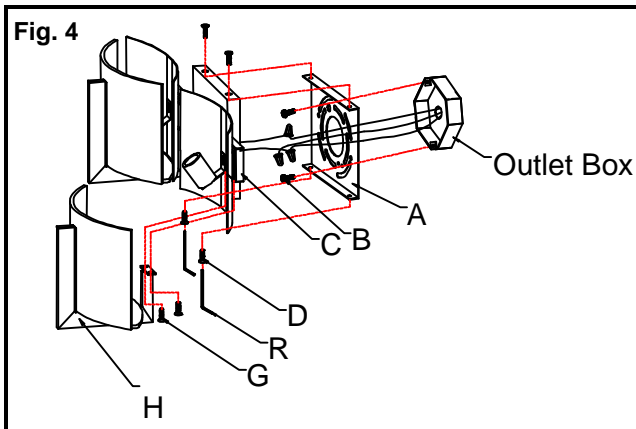

Note: Illustration (Fig.1) on this manual is for installation purposes only. It may or may not be identical to the fixture purchased.

LA-1917E



american
lighting
association