

INSTALLATION INSTRUCTIONS

For Model 6461-1

READ AND SAVE THESE INSTRUCTIONS

WARNING! SHUT POWER OFF AT FUSE OR CIRCUIT BREAKER

AVERTISSEMENT! COUPER LE COURANT AU NIVEAU DES FUSIBLES OU DU DISJONCTEUR.

WARNING: This fixture must mount upward.

MOUNTING THE SQUARE STRAP (Fig.1)

1. Shut off the power at the circuit breaker and remove old fixture, including the crossbar.
2. Carefully unpack your new fixture and lay out all the parts on a clear area. Take care not to lose any small parts necessary for installation.
3. Attach Square Strap (A) to the outlet box using two outlet box Screws (B). The side of the Square Strap marked "GND" must face out.

CONNECTING THE WIRES (Fig. 2)

4. At this point, connect the electrical wires as follow, Connect the black wire from the fixture to the black house (hot) wire. Connect the white wire from the fixture to the white (neutral) house wire. Make sure all wire nuts are secured. You may wrap the connections with electrical tape. If your outlet box has a ground wire (green or bare copper) connects fixture's ground wire to it. Otherwise connect fixture's ground wire directly to the crossbar using the green screw provided.

FINISHING THE INSTALLATION (Fig. 1)

5. After the wires are connected, tuck them carefully inside the outlet box as you hold the backplate (E) onto the Square Strap (A). Adjust Square Strap (A) and the backplate (E) to align the holes, then secure them by threading the four Allen Screws (D) with wrench (C) until snug.
6. Place glass (G) and Socket Sleeve (I) over the socket, then fasten them with socket ring (H) by using the included Spanner (F). For replacing the glass at a later date, Reverse above-mentioned step can get the glass. **CAUTION:** The glass (G) must be accurately centered to keep away from the Metal Accent.
7. Install the bulb in accordance with the fixture's specification. (DO NOT EXCEED THE MAXIMUM WATTAGE RATING!!)(NE PAS DEPASSER LA PUISSANCE NOMINALE MAXIMALE!).

Your installation is now complete. Return power to the junction box and test the fixture.

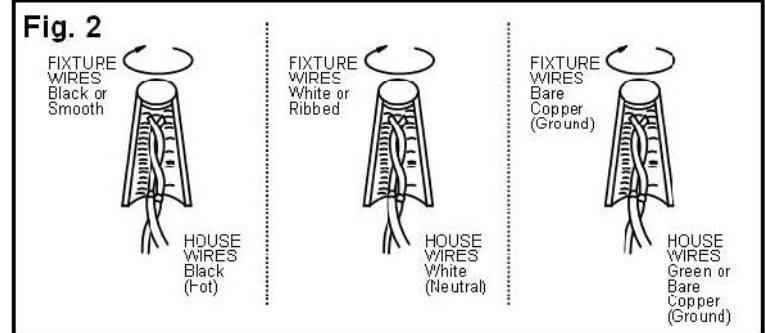
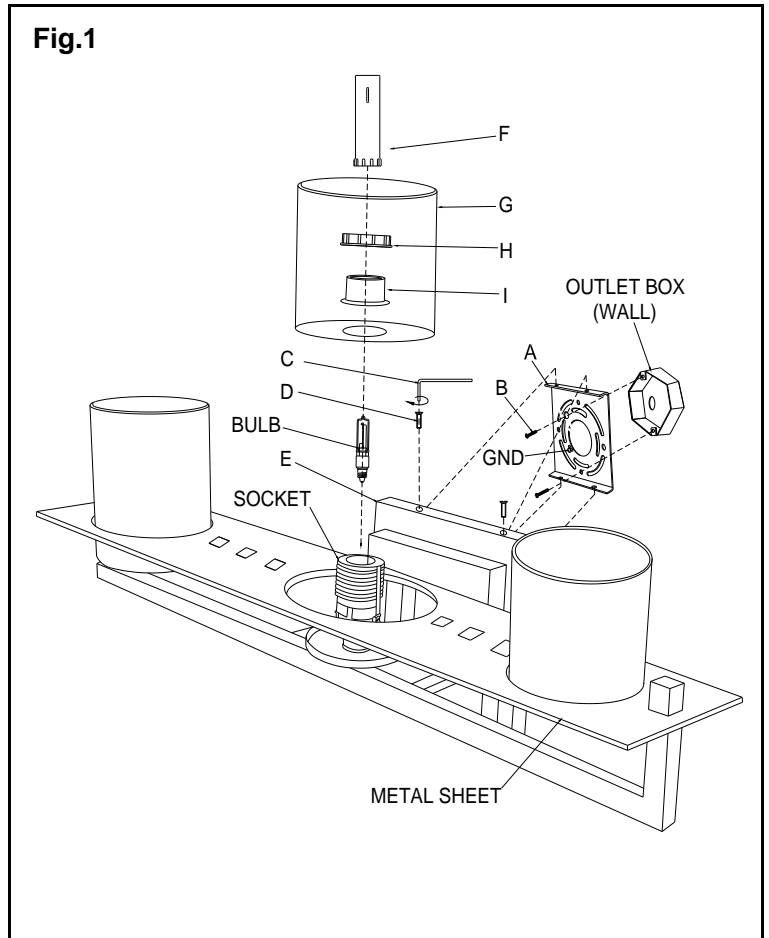

Note: Illustration (Fig. 1) on this manual is for installation purposes only. It may or may not be identical to the fixture purchased.

LA-1929E