

INSTALLATION INSTRUCTIONS

Item# P1235

READ AND SAVE THESE INSTRUCTIONS

WARNING! SHUT POWER OFF AT FUSE OR CIRCUIT BREAKER.

AVERTISSEMENT! COUPER LE COURANT AU NIVEAU DES FUSIBLES OU DU DISJONCTEUR.

ASSEMBLING THE FIXTURE (Fig.1)

- 1 Shut off power at the fuse box or circuit breaker. If necessary, remove the old fixture including the mounting hardware.
- 2 Carefully remove the fixture from the carton and check that all parts are included as show in Figure 1.
- 3 Thread screws (A) into the pre-drilled holes in the circular strap (B) spaced the same distance apart as the holes in the back plate of the fixture body and secure with hex nut (D). The distance of screws (A) into circular strap (B) may be adjusted if necessary.
- 4 Attach the circular strap (B) to the junction box using the mounting screws (C) (size: #8-32N*L0.5"). The side of circular strap (B) marked "GND" must face out.

CONNECTION THE WIRES (Fig. 2)

- 5 Connect the electrical wires as shown in Fig.2, making sure that all wire nuts are secured. If your outlet has a ground wire (green or bare copper), connect the fixture's ground Wire to it. Otherwise, connect the fixture's ground wire directly to the circular strap using the green screw provided. Tuck the wire connections neatly into the junction box.

FINISHING THE INSTALLATION (Fig. 1)

- 6 Align back plate (E) onto the circular strap (B) and secure with ball nuts (F).
- 7 To prevent moisture from entering the outlet box and causing a short circuit, use clear caulking (i.e. Indoor/Outdoor silicone sealant) to outline the outside of fixture back plate where it meets the wall leaving a space at bottom to allow moisture a means to escape (Fig.3).

Your installation is now complete. Return power to the junction box and test the fixture.

IMPORTANT: Fixture should be installed by a qualified electrician to ensure proper wiring and installation.
Dimmable with C-L (CFL & LED) type and Incandescent/Halogen type dimmers

Fig. 1

Junction Box

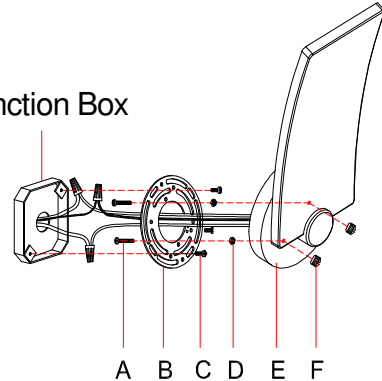

Set# A-020
- Circular Strap
- Ground Screw
- Mounting Screw*2

Fig. 2

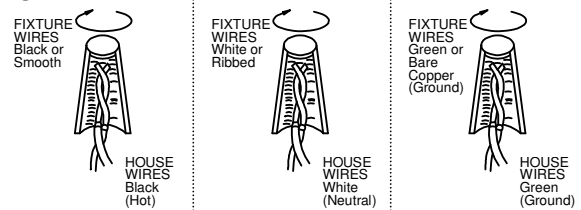

Fig. 3

