

INSTALLATION INSTRUCTIONS

For P2266-084-L

WARNING! SHUT POWER OFF AT FUSE OR CIRCUIT BREAKER.

AVERTISSEMENT! COUPER LE COURANT AU NIVEAU DES FUSIBLES OU DU DISJONCTEUR.

MOUNTING THE FIXTURE (Fig. 1)

1. Shut off power at the fuse box or circuit breaker box. If necessary, remove the existing fixture and its mounting hardware.

2. Carefully remove the new fixture from the carton and check that all parts are included as shown in the illustration.

3. Rotate frames (O,P) and ring (R,Q) to the desired positions.

4. Attach mounting plate (C) to junction box (A) (not included) using mounting screws (E) (Size: #8-32*1/2"L). The side of the mounting plate marked "GND" must face out.

5. Determine the desired hanging height and thread rods (K2 and K1) to all thread on top of fixture body (M). Attach canopy (J) by screwing onto rod (K1). Carefully pass the wires through each rod during assembly. Note: Remove all thread if installing with one 6" rod only.

6. There are two drivers inside the canopy, connect driver output wire to LED wire with wire nuts (F) as below:

-Red driver output wire (labeled 700mA Output+) to red LED wire (labeled 700mA LED+)

-Black driver output wire (labeled 700mA Output-) to black LED wire (labeled 700mA LED-)

-Red driver output wire (labeled 750mA Output+) to red LED wire (labeled 750mA LED+)

-Black driver output wire (labeled 750mA Output-) to black LED wire (labeled 750mA LED-)

7. The support cable is provided to support the weight of the fixture while wiring.

Align the fixture to mounting plate (C) and attach hook (D) on the end of support cable (H) into a slot located on mounting plate (C). Carefully allow the support cable (H) to support the weight of the fixture while wiring.

CONNECTION THE WIRES (Fig. 2)

8. Connect the electrical wires as shown in Fig. 2, making sure that all wire connectors are secured. If your junction box (A) has a ground wire (green or bare copper), connect the fixture's ground wire to it. Otherwise, connect the fixture's ground wire directly to the mounting plate (C) using the green screw provided. After the wires are connected, tuck them carefully into the junction box (A).

FINISHING THE INSTALLATION (Fig. 1)

9. Align canopy (J) to mounting plate (C) and secure with screws (G).

Your installation is now complete. Return power to the junction box and test the fixture.

Fig. 1

A-021-145D for P2266-084-L

- Mounting plate (C)
- Ground screw (N)
- Mounting screw*2 (E)

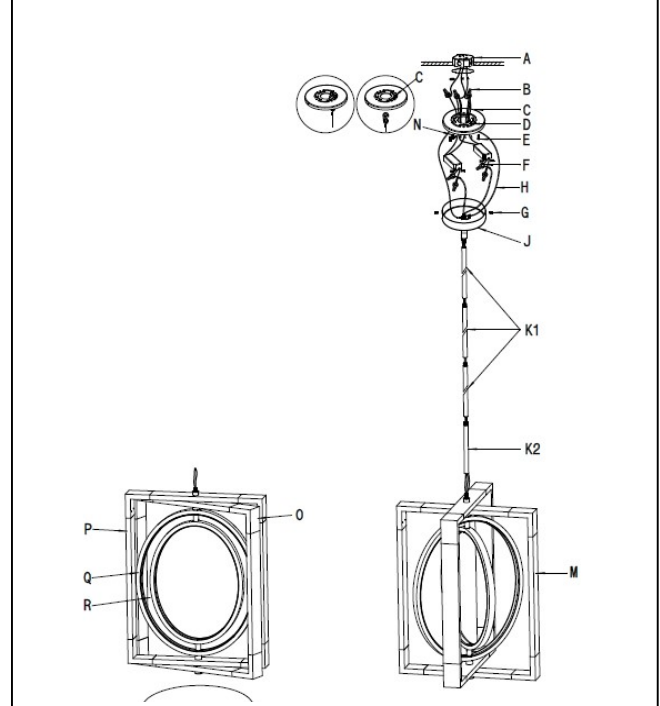
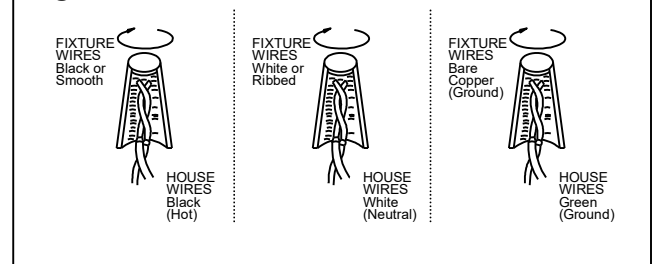

Fig. 2



IMPORTANT: Fixture should be installed by a qualified electrician to ensure proper wiring and installation.

CAUTION/ATTENTION: When handling the fixture, do not apply pressure to the LEDs. Hold the fixture by the base or fixture body only.

Dimmable with ELV and/or LED compatible wall dimmer

