

INSTALLATION INSTRUCTIONS FOR P5490-172-L

For LED Chandelier

READ AND SAVE THESE INSTRUCTIONS

WARNING! SHUT POWER OFF AT FUSE OR CIRCUIT BREAKER
AVERTISSEMENT! COUPER LE COURANT AU NIVEAU DES FUSIBLES OU DO DISJONCTEU

ASSEMBLING THE FIXTURE (Fig.1)

1. Shut off power at the fuse box or circuit breaker box and remove the old fixture including the mounting hardware.
2. Carefully unpack your new fixture and lay out all the parts in a clear area. Take care not to misplace any small parts necessary for installation.
3. Attach mounting plate (A) to junction box (not included) using mounting screws (C) (Size: 8-32*1/2"L). The side of mounting plate (A) marked "GND" must face out.
4. Adjust 5 strainers (O) to the length you desire.

CONNECTING THE WIRES (Fig.2)

5. Connect the electrical wires as shown in Fig.2, making sure that all wire connectors are secured. If your junction box has a ground wire (green or bare copper), connect fixture's ground wire to it. Otherwise, connect the fixture's ground wire directly to the mounting plate (A) using the green screw (B) provided.

COMPLETING THE INSTALLATION

6. Align canopy (E) onto mounting plate (A) and secure with screws (D).

Your installation is now complete. Return power to the junction box and test the fixture.

CAUTION /ATTENTION: When handling fixture, do not apply pressure to LEDs. Hold fixture by the base only.

Replacing LED module (Fig. 3)

The LED module can be replaced by a qualified electrician without cutting of wire and without damage to any decorative element to which the fixture is attached. See installation steps for more details (Fig.3.)

Warning: Turn off power at the circuit breaker before replacing LED module.

- a. Remove screws (G) and remove the end cap (H) and glass panel (I).
- b. Carefully disconnect the quick connector (J K). Loosen screws (L) and washer (M), then carefully remove LED module (N).
- c. Reverse steps a - b for installing new LED module (Fig.3).

Note: The LED module should be provided by a specified supplier.

IMPORTANT: Fixture should be installed by a qualified electrician to ensure proper wiring and installation.

Dimmable with ELV and/or LED compatible wall dimmer switches.

Fig.1

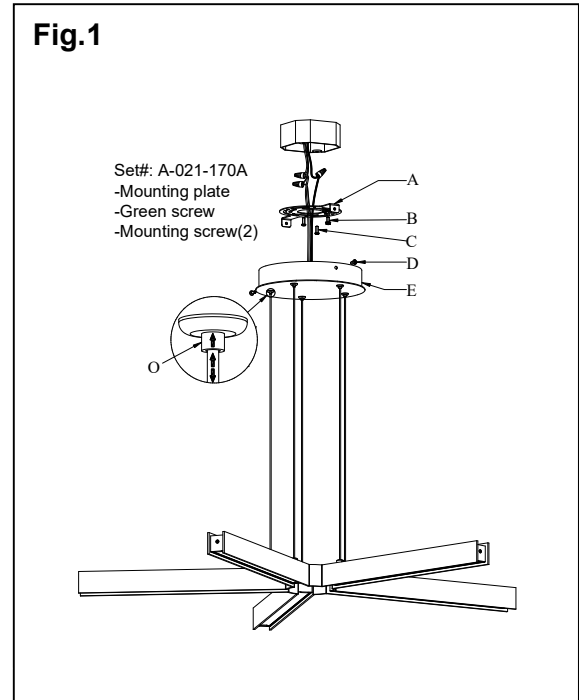

Fig.3

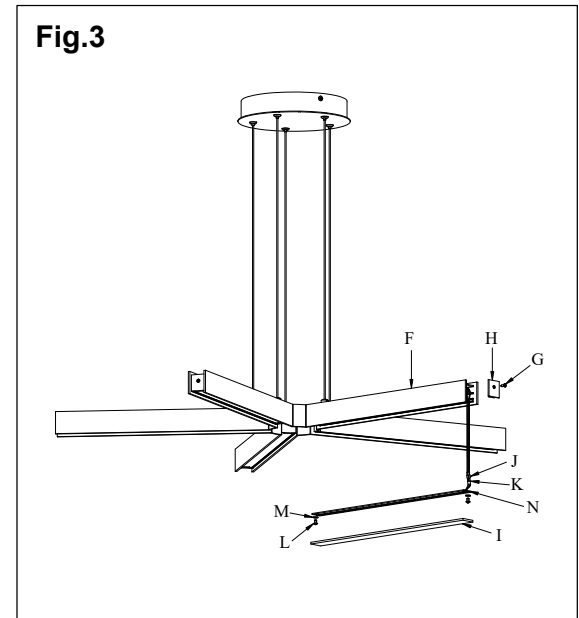

Fig.2

