

INSTALLATION INSTRUCTIONS

For Model # P5951-077

READ AND SAVE THESE INSTRUCTIONS

WARNING! SHUT POWER OFF AT FUSE OR CIRCUIT BREAKER.
AVERTISSEMENT! COUPER LE COURANT AU NIVEAU DES FUSIBLES OU DU DISJONCTEUR.

WARNING

- Risk of shock, do not supply power to fixture before assembly is complete.
- Do not exceed the maximum wattage rating

MOUNTING INSTRUCTIONS

1. Shut off power at the circuit breaker and remove the old fixture and Mounting Hardware.
2. Carefully unpack your new fixture and lay out all the parts on a clear area. Take care not to lose any small parts necessary for installation.
3. Secure Mounting Bracket (A) using Screws (B) to the Outlet Box. The side of the Mounting Bracket with "GND" marked on it and two convex points must face out.
4. Pass all the electrical wires through the Mounting bracket.

CONNECTING THE WIRES (Fig. 1)

5. Connect the electrical wires as shown in Fig. 1, making sure that all wire connectors (C) are secured. If your outlet has a ground wire (green or bare copper), connect the fixture's Ground Wire to it. Otherwise, connect the fixture's Ground Wire directly to the Mounting Bracket or Reinforcement Plate using the Green Screw provided.

FINISHING THE INSTALLATION

6. Fasten the fixture body onto mounting bracket (A) using screws (D).
7. Install 1*60w G9 Xenon Light Bulbs in accordance with the lamp's specifications. **(DO NOT EXCEED THE MAXIMUM WATTAGE RATING!). (NE PAS DEPASSER LA PUISSANCE NOMINALE MAXIMALE!)**
8. Slide the glass (E) into the slots on each side of the fixture body.

IMPORTANT: FIXTURE SHOULD BE INSTALLED BY A QUALIFIED ELECTRICIAN TO ENSURE PROPER WIRING AND INSTALLATION.

*****Caution, to avoid being burned, wait for the fixture to cool, prior to replacing the light bulbs. *****

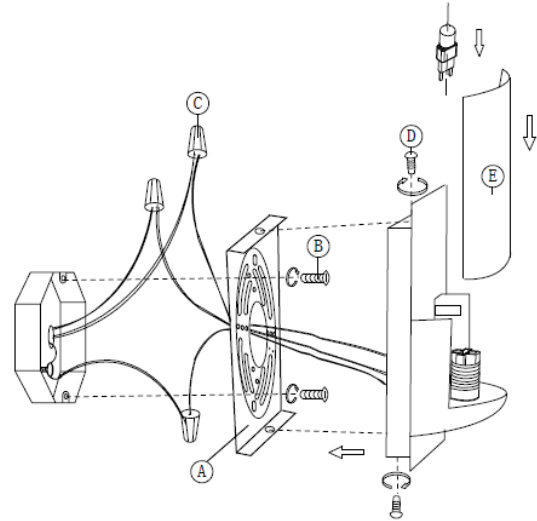

Fig. 1

