

INSTALLATION INSTRUCTION FOR FIXTURE #3071-613

**WARNING! SHUT POWER OFF AT FUSE OR CIRCUIT BREAKER.
AVERTISSEMENT! COUPER LE COURANT AU NIVEAU DES FUSIBLES OU DU DISJONCTEUR.**

MOUNTING THE FIXTURE (FIG. 1)

1. Shut off the power supply at the fuse box or circuit breaker. If necessary, remove the old fixture from wall. Including the mounting hardware.
2. Carefully remove the new fixture from the carton and check that all parts are included as shown in the illustration.
3. Attach the mounting plate (E) to the outlet box using the outlet box screws (F). The side of the mounting plate marked "GND" must face out.
4. Follow the wiring instructions carefully (See Fig.2).
5. Attach the fixture wall plate (G) over the mounting plate (E) by protruding the mounting screws (H) through the mounting holes on the wall plate (G) and securing with ball nut (D) tightly.
6. Install the glass shade (B) over the socket (C) and secure with socket ring (A).
7. Install the bulb (included) in accordance with fixture's specifications. **(DO NOT EXCEED THE MAXIMUM WATTAGE RATING!) (NE PAS DEPASSER LA PUISSANCE NOMINALE MAXIMALE!).**

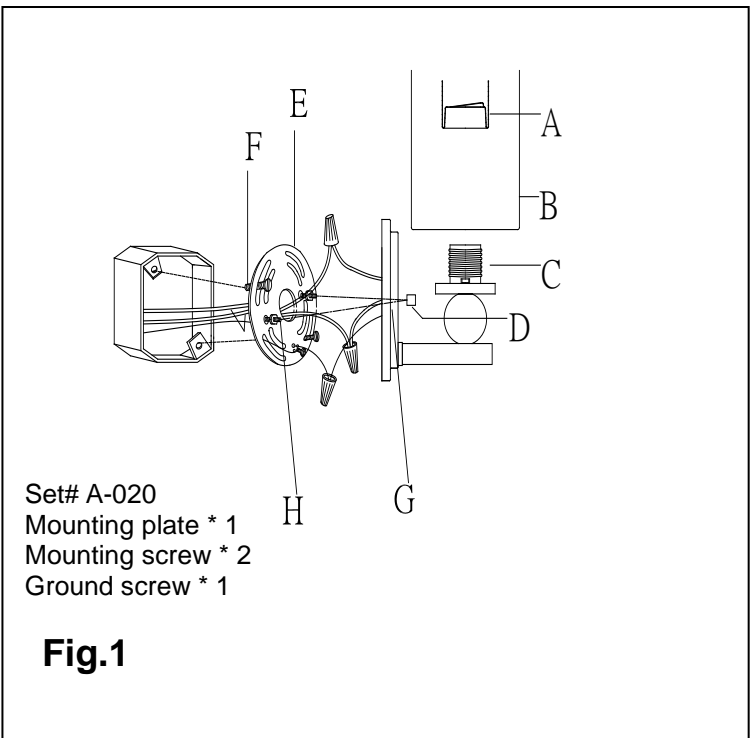

CONNECTING THE WIRES (FIG. 2)

1. At this point, connect the electrical wires as shown in Fig. 2, making sure that all wire connectors are secured. If your outlet box has a ground wire (green or bare copper), connect the fixture's ground wire to it. Otherwise, connect the fixture's ground wire directly to the mounting strap using the green screw provided.
2. Tuck the wire connections neatly into the wall outlet box.

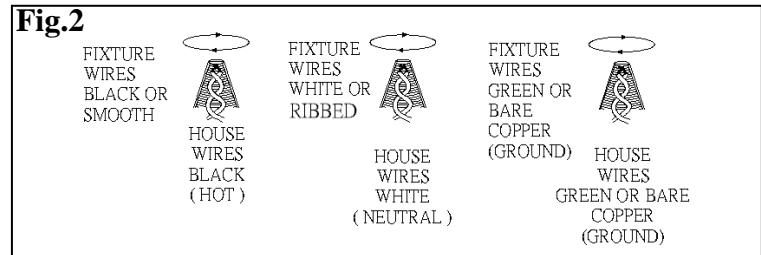

Your installation is now complete. Return power to the junction box and test the fixture.

